

# ASSEMBLY INSTRUCTIONS

## LIST OF PARTS

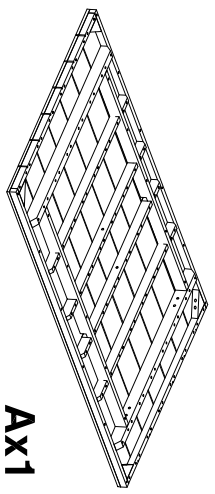

**Ax1**

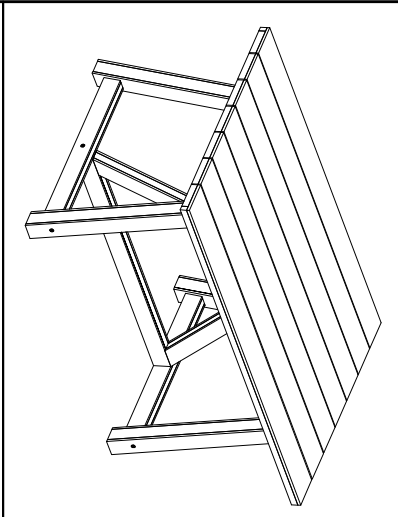
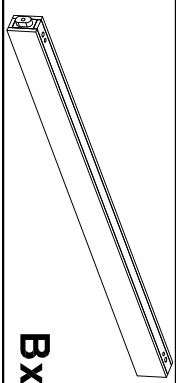

**Bx1**

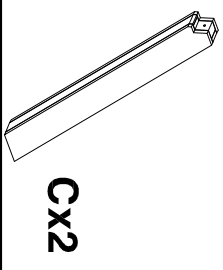

**Cx2**

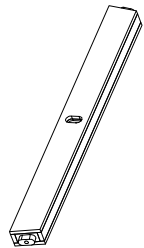

**Dx2**

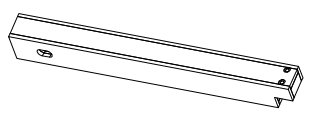









**Ex2**



**Fx2**

## LIST OF HARDWARE

| No. | Hardware   | Q.ty |
|-----|--|------|
| 1   | M8 x 110  | 04   |
| 2   | M8 x 90   | 02   |
| 3   | M8 x 65   | 08   |
| 4   | Nuts      | 06   |
| 5   | M6 x 90    | 02   |
| 6   | M6 x 45     | 02   |
| 7   | Allen Key   | 01   |
| 8   | M6 x 55     | 01   |

